



US00D673978S

(12) **United States Design Patent**
Hsu et al.

(10) **Patent No.:** **US D673,978 S**
(45) **Date of Patent:** **** Jan. 8, 2013**

(54) **INTAKE MANIFOLD**

(75) Inventors: **David Hsu**, Norco, CA (US); **Clinton Yee**, Corona, CA (US); **Ming Wong**, San Diego, CA (US)

(73) Assignee: **Group-A Autosports, Inc.**, Norco, CA (US)

(**) Term: **14 Years**

(21) Appl. No.: **29/415,861**

(22) Filed: **Mar. 15, 2012**

(51) **LOC (9) Cl.** **15-01**

(52) **U.S. Cl.** **D15/5**

(58) **Field of Classification Search** D15/1-6;
23/41.73; 123/210, 41.7, 184.21, 184.35,
123/184.43, 184.48

See application file for complete search history.

(56) **References Cited**

U.S. PATENT DOCUMENTS

6,637,397	B2 *	10/2003	Ward et al.	123/184.55
D517,567	S *	3/2006	Teeter	D15/5
7,086,365	B1 *	8/2006	Teeter	123/184.21
7,124,727	B2 *	10/2006	Kogawa et al.	123/195 R
7,434,558	B2 *	10/2008	Shinada et al.	123/184.47
D638,033	S *	5/2011	Ballard	D15/5
8,091,526	B2 *	1/2012	Tanikawa et al.	123/184.21

D654,094	S *	2/2012	Dralle	D15/5
8,220,430	B2 *	7/2012	Gupta	123/184.21
2002/0083911	A1 *	7/2002	Ward et al.	123/184.55
2007/0199535	A1 *	8/2007	Shinada et al.	123/184.57
2010/0294225	A1 *	11/2010	Randall et al.	123/184.21
2010/0294226	A1 *	11/2010	Gupta	123/184.21
2010/0294227	A1 *	11/2010	Magnan et al.	123/184.55

* cited by examiner

Primary Examiner — T. Chase Nelson

Assistant Examiner — Ania Aman

(74) *Attorney, Agent, or Firm* — Steven N. Fox, Esq.

(57) **CLAIM**

The ornamental design for an intake manifold, as shown and described.

DESCRIPTION

FIG. 1 is a front perspective view of an intake manifold according to the present invention;

FIG. 2 is a top view thereof;

FIG. 3 is a bottom view thereof;

FIG. 4 is a front view thereof;

FIG. 5 is a rear view thereof;

FIG. 6 is a right side view thereof;

FIG. 7 is a left side view thereof; and,

FIG. 8 is a bottom perspective view.

The broken lines in the drawings illustrate environmental structure and form no part of the claimed design.

1 Claim, 6 Drawing Sheets

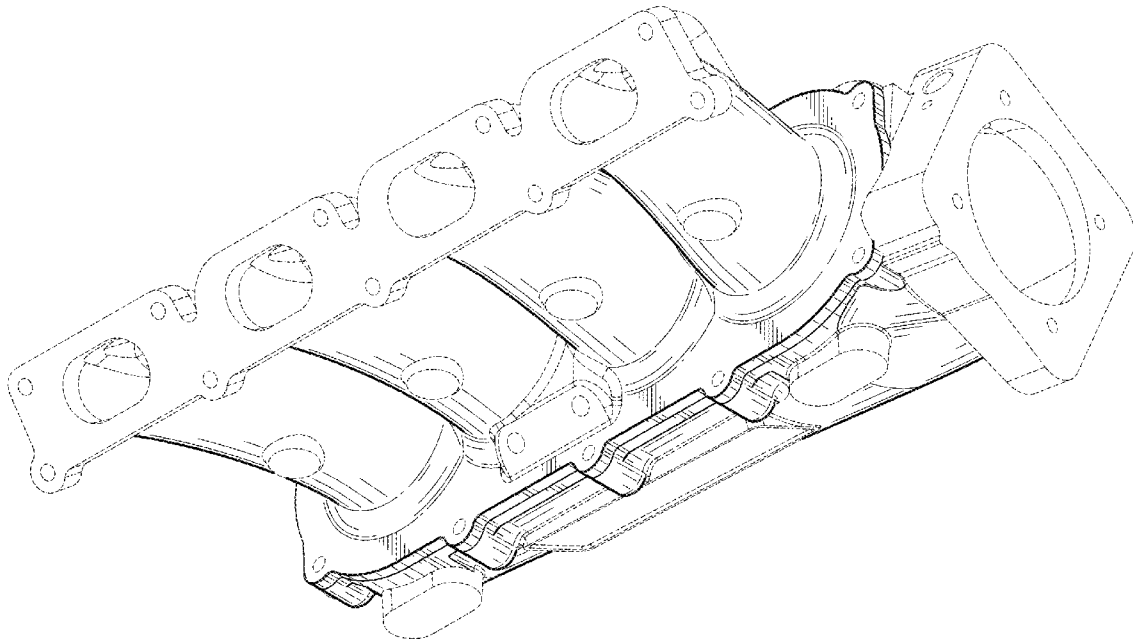

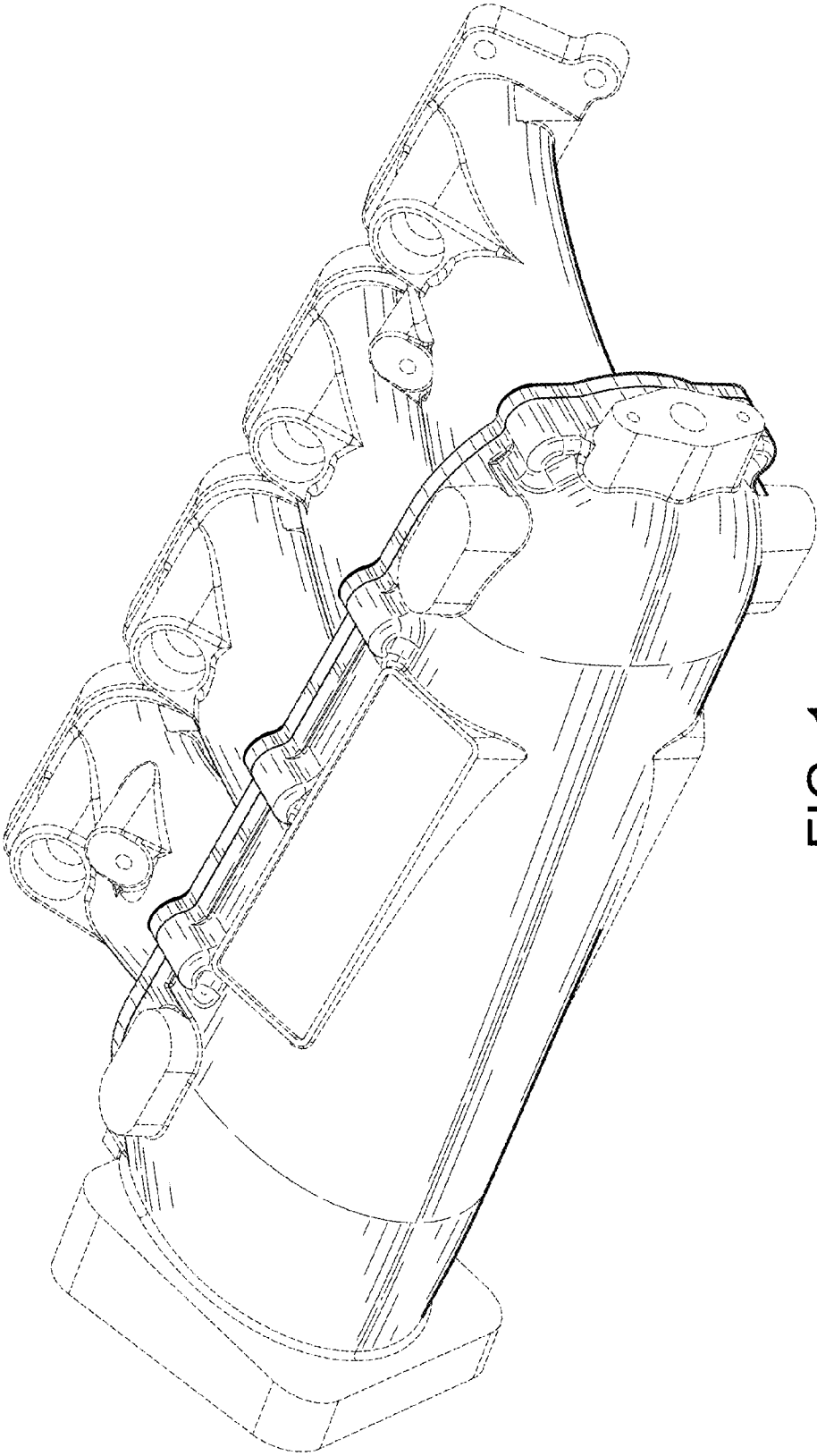

FIG. 1

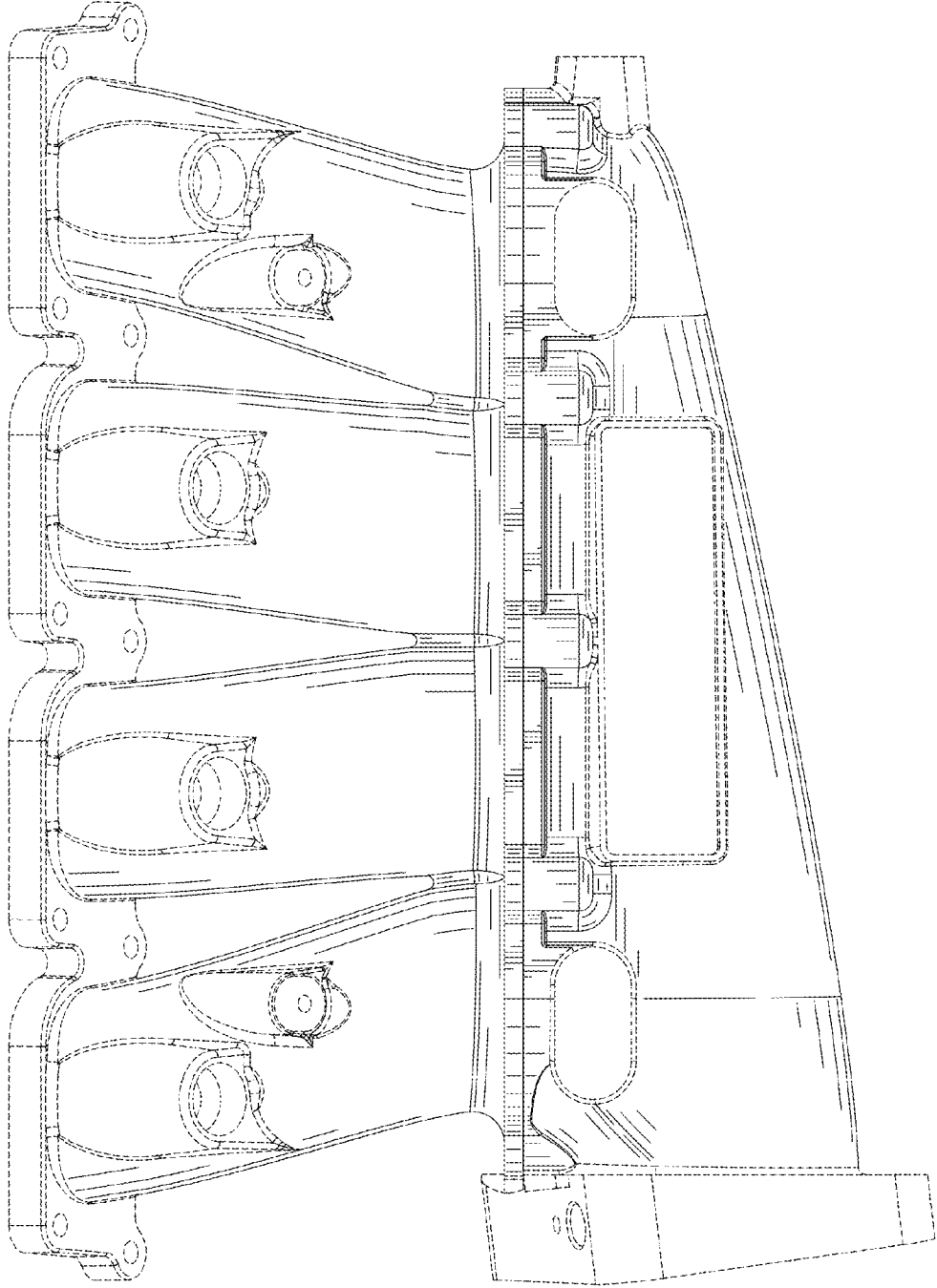

FIG. 2

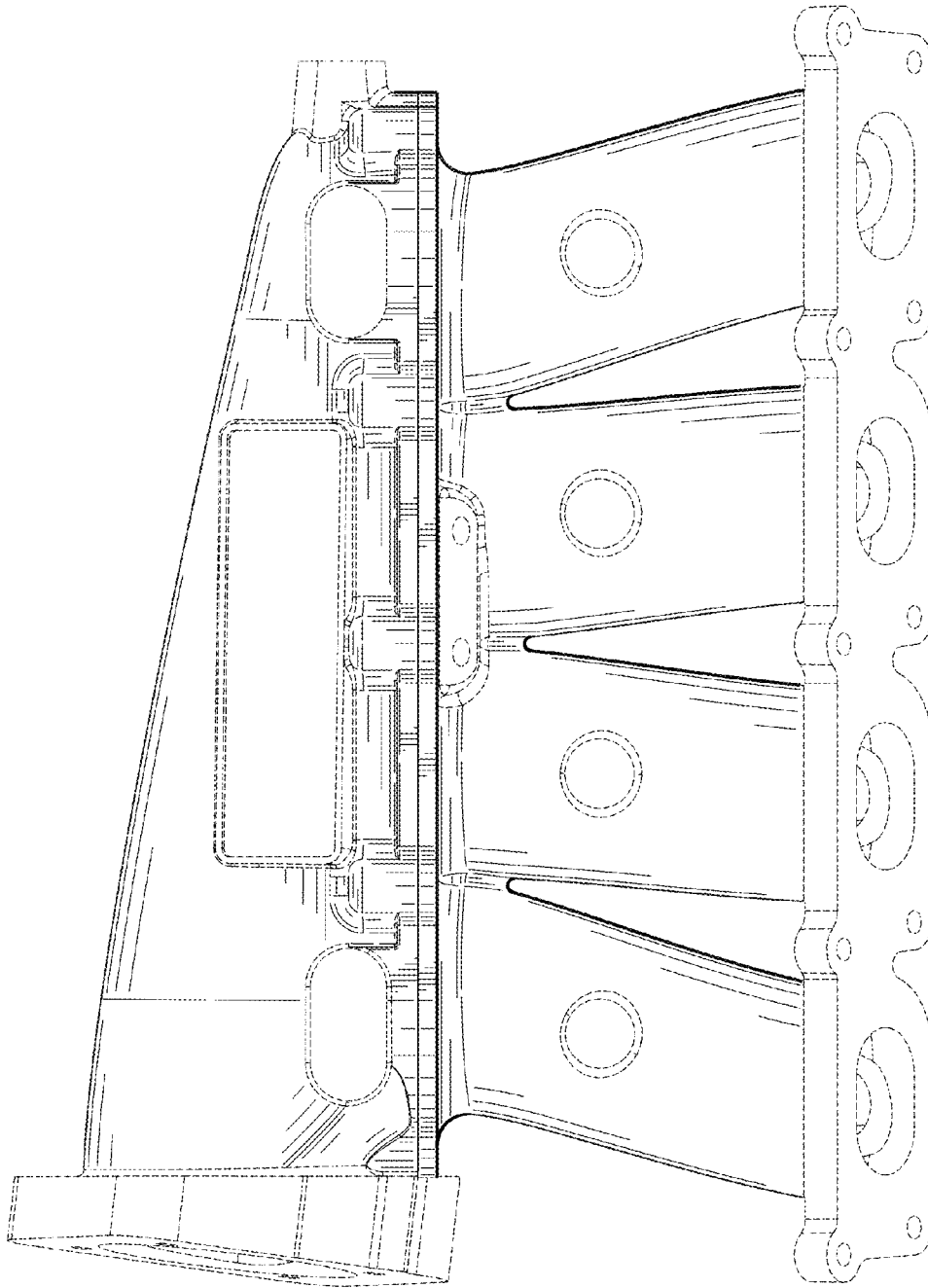

FIG. 3

FIG. 4

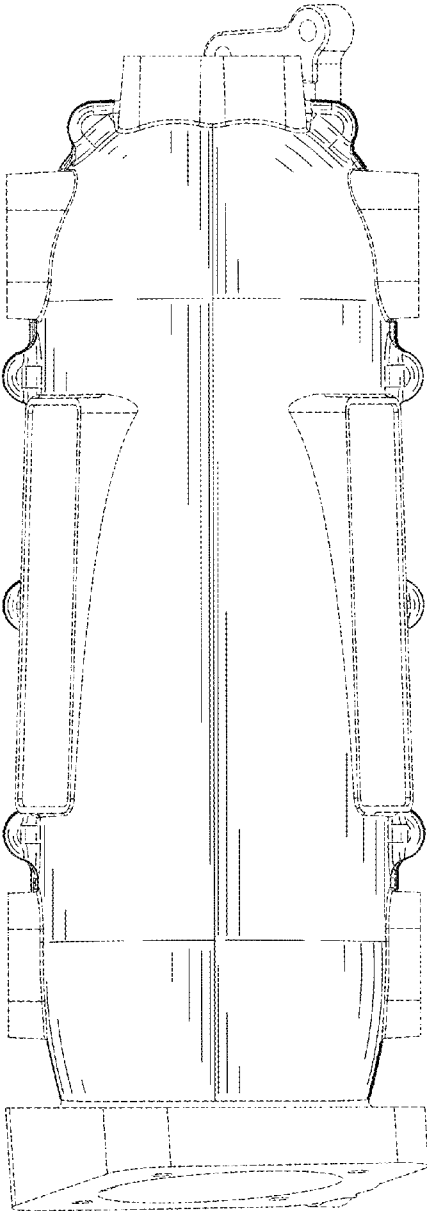
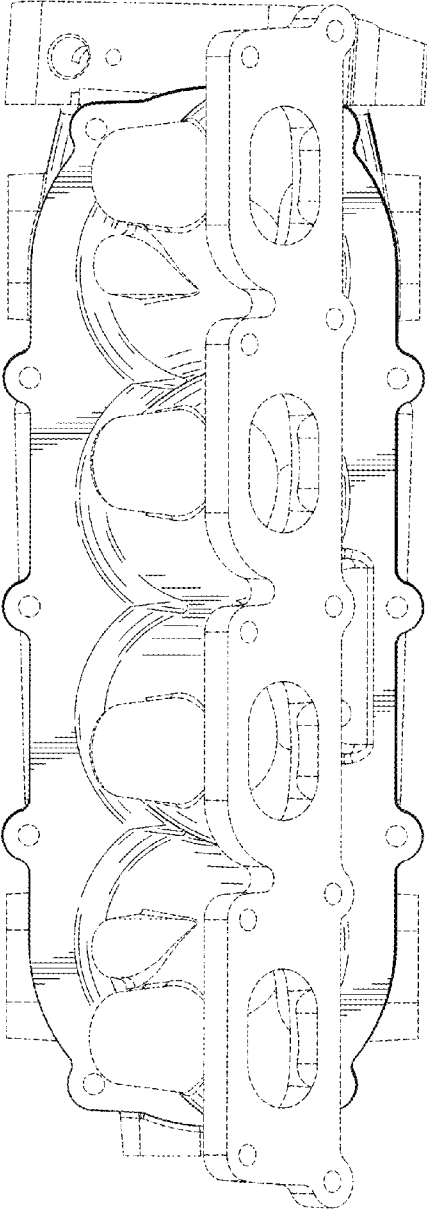

FIG. 5



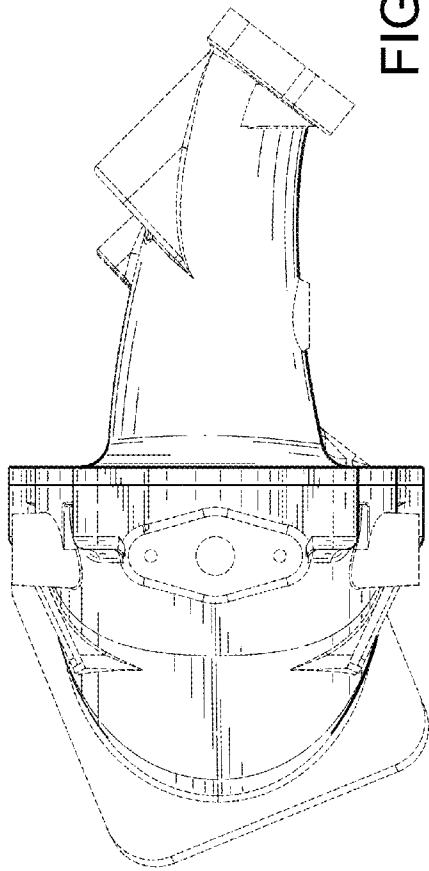

FIG. 6

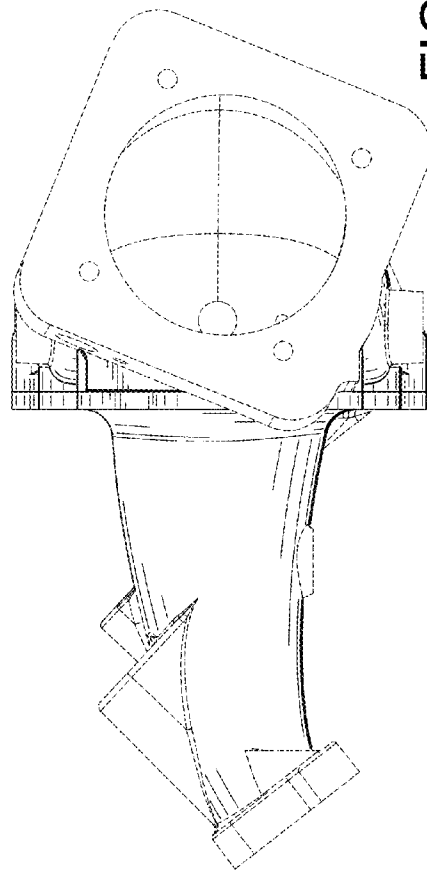

FIG. 7

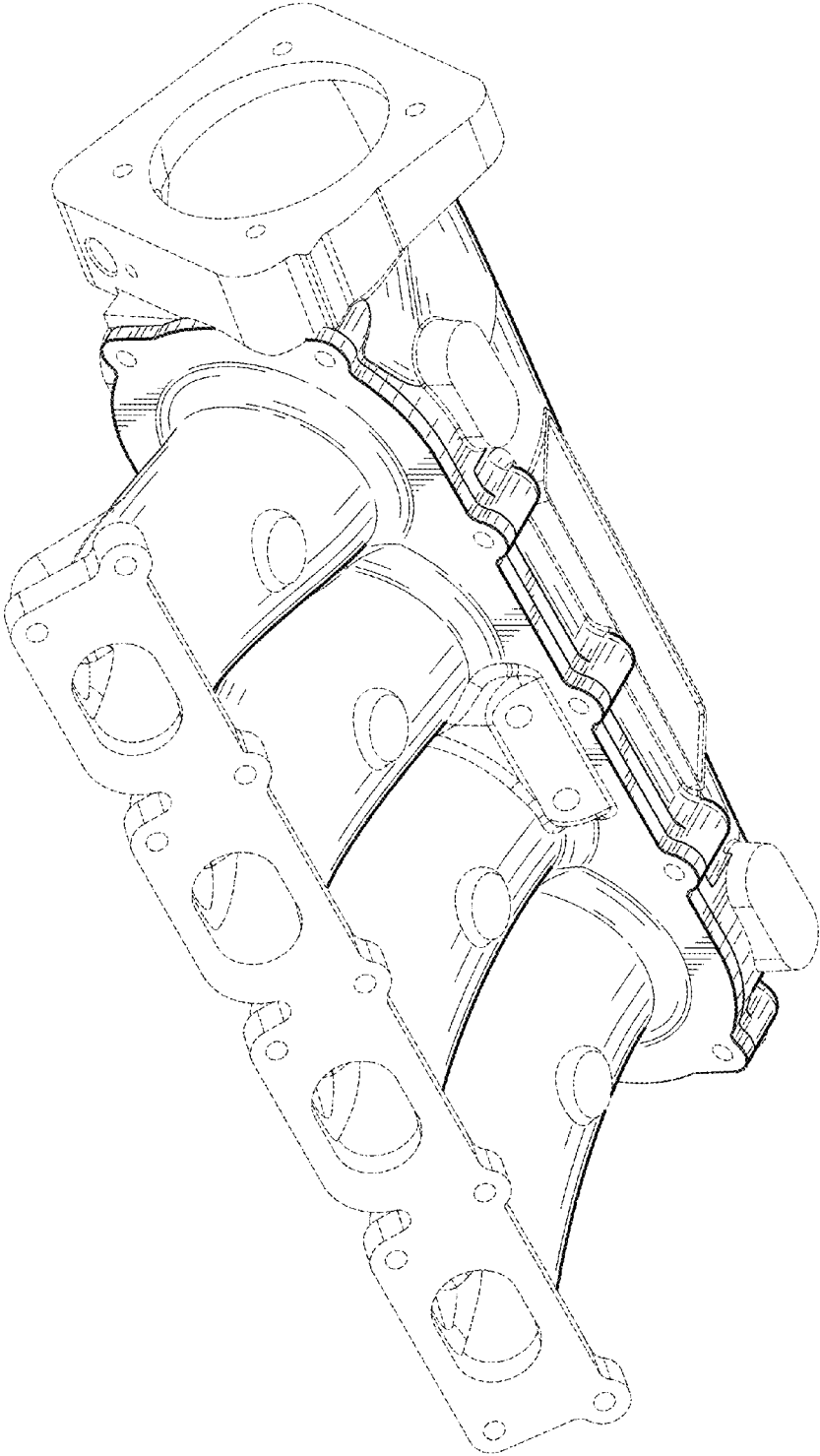

FIG. 8